

BLOC Nº 2

EL NOSTRE POBLE .- EL MEU BARRI

ESTRUCTURES DE CONVERSA	SITUACIONS COMUNICATIVES
<p>- DEMANAR INFORMACIÓ SOBRE UN FET O UNA ACTIVITAT: (qué ...? qué véns? Int+o?. Quant val?. Cap on he d'anar?.</p> <p>- DEMANAR PER UNA ADREÇA CONCRETA: On és aquest carrer? Sap on puc trobar un/una supermercat, farmàcia,...?.</p> <p>-SABER DEMANAR L'HORA: Quina hora és?.</p> <p>DEMANAR EL PREU: quant val? val ... pessetes</p>	<p>- EXPRESSAR GRAT: M'agrada (molt) + SN M'agrada molt anar al cinema</p> <p>- EXPRESSAR PREFERÈNCIA: ... /M/ agrada més (... que pas)</p> <p>- NOCIÓ D'ACCESSIBILITAT /obert/ : La botiga és oberta /tancat/: El museu és tancat el dilluns /ocupat/ : El wàter està ocupat</p>

VOCABULARI COMPLEMENTARI

- DIRECCIÓ I SENTIT DEL MOVIMENT:
amunt, avall, endavant, endarrera, a la dreta, a l'esquerra, davant, darrera, sobre, sota,...
- CONEIXEMENT DEL RELLOTGE I INDICACIONS HORÀRIES :
- CARTELLERES (d'espectacles, cinemes,)
- SABER BUSCAR INFORMACIÓ .- ORIENTAR-SE EN UN PLÀNOL
- ...

BLOC Nº 2

EL NOSTRE POBLE .- EL NOSTRE BARRI

VOCABULARI		ACCIONS
Cotxe	Revista	Xocar
Camió	Farmàcia	Comprar
Autobús	Vorera	Escombrar
Bicicleta	Calçada	Vendre
Taxi	Fanal	Regar
Escombriaire	Moto	Caminar
Contenedor	Flor	Fotografiar
Bar	Ambulància	Saludar
Carnisseria	Bústia	Mirar
Fleca/Forn de pa	Carter	Apagar
Banc	Tren	Podar
Plaça	Carta	Olorar
Pas de vianants	Postal	Punxar-se una roda
Semàfor	Segell	
Balcó	Correus	
Arbre	Guàrdia Municipal	
Jardí	Estació d'autobusos	
Font	Estació de trens	
Surtidor		
Hospital		
Aparador		
Senyal de trànsit		
Quiosc		
Revista		
Farmàcia		
Vorera		
Calçada		
Fanal		

BLOC Nº 2

EL NOSTRE POBLE .- EL MEU BARRI

El nostre poble .- El meu barri.

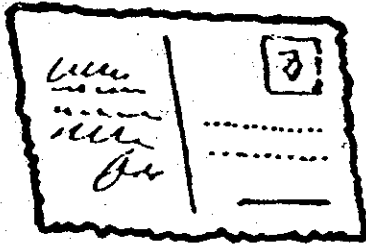

POSTAL

postal

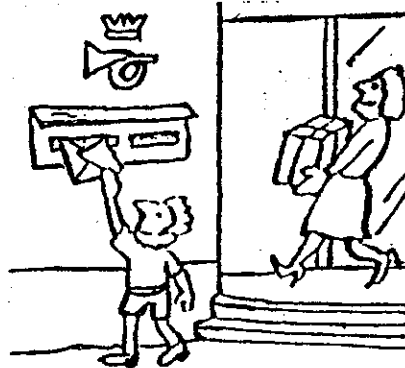

CORREUS

correus



HOSPITAL

hospital

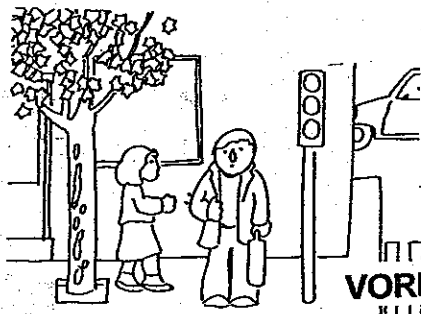

VORERA

vorera

ÇALÇADA

calçada

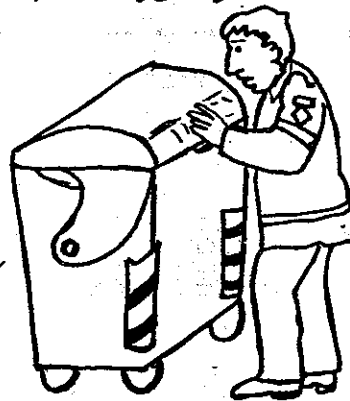

CONTENIDOR

contenedor



TAXI

taxi

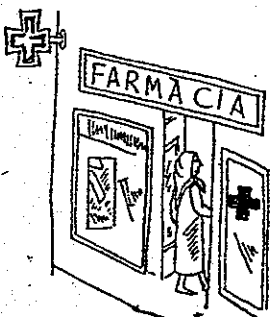

FARMÀCIA

farmàcia

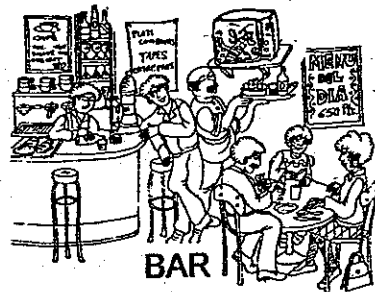

BAR

bar



CARNISSERIA

carnisseria.

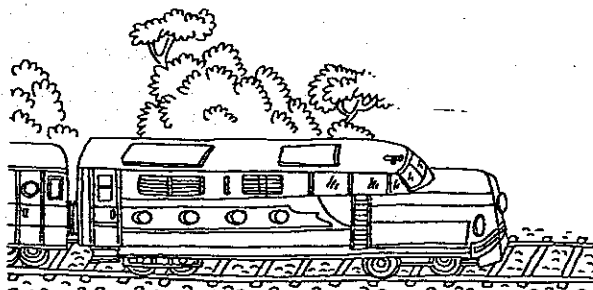

TREN

tren



FLECA / FORN DE PA

fleca / forn de pa

BLOC Nº 2

EL NOSTRE POBLE .- EL MEU BARRI

El nostre poble .- El meu barri.

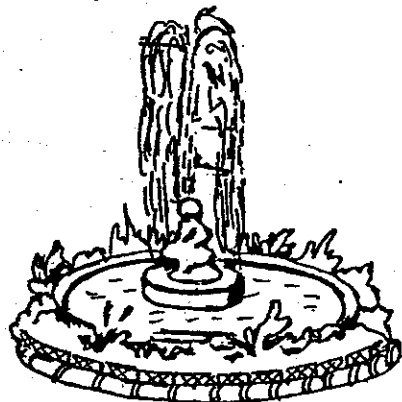

SURTIDOR
surtidor



AMBULÀNCIA
ambulància



SEMÀFOR
semàfor



FONT
font



CARTER
carter



SEGELL
segell

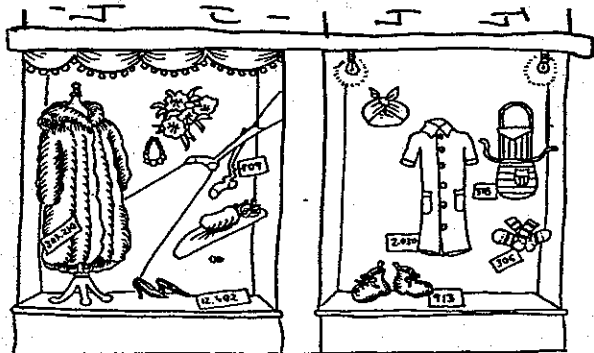

APARADOR
aparador

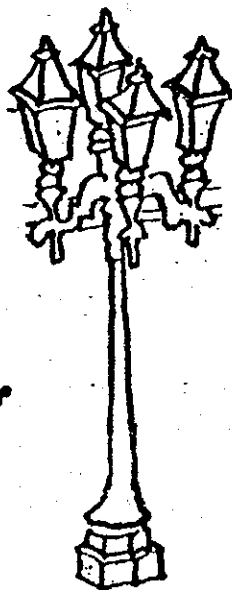

FANAL
fanal

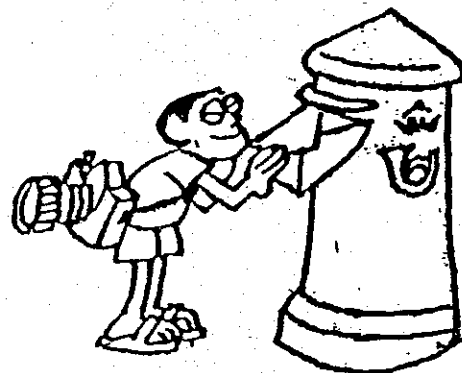

BÚSTIA
bústia

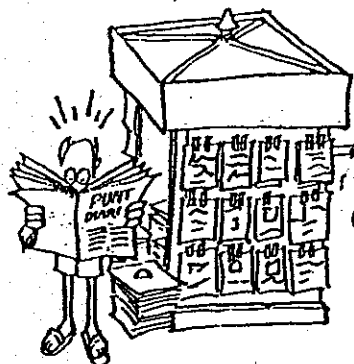

QUIOSC
quiosc



GUÀRDIA MUNICIPAL
guàrdia municipal

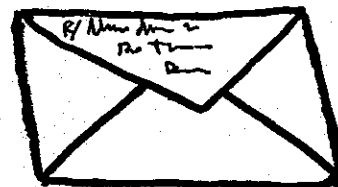

CARTA
carta

BLOC Nº 2

EL NOSTRE POBLE .- EL MEU BARRI

El nostre poble .- El meu barri.

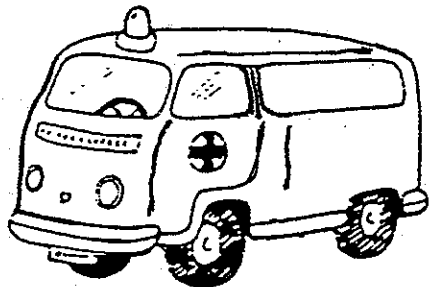

AMBULÀNCIA
ambulància

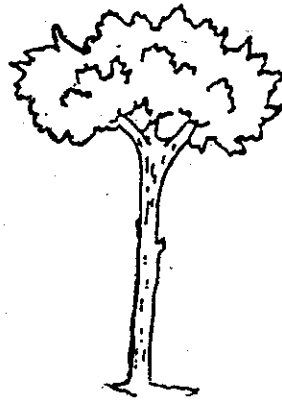

ARBRE
arbre

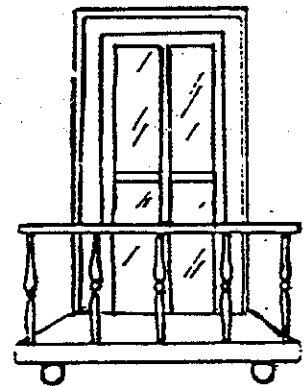

BALCÓ
balcó

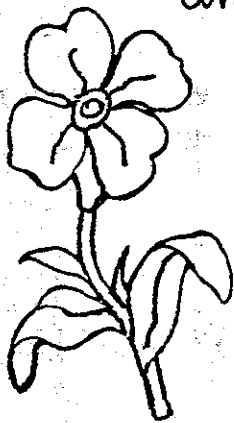

FLOR
flor

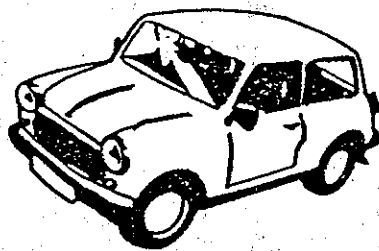

COTXE
cotxe

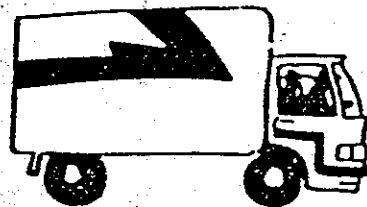

CAMIÓ
camió

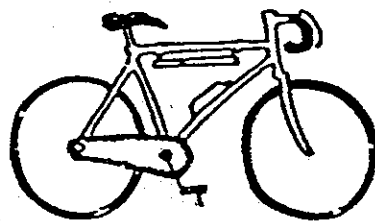

BICICLETA
bicicleta

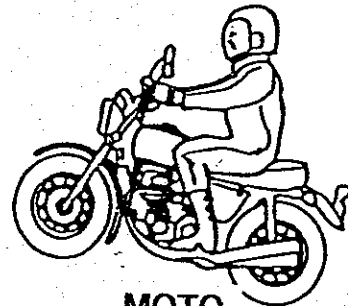

MOTO
moto

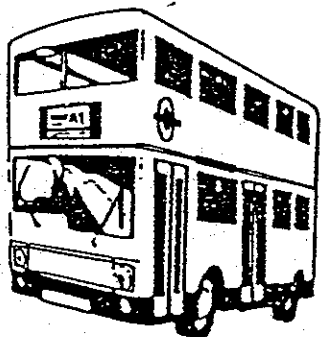

AUTOBÚS
autobús

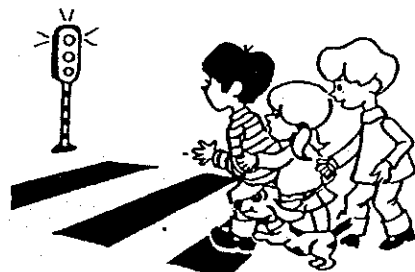

PAS DE VIANANTS
pas de vianants



ESCOMBRIARE
escombriare

BLOC Nº 2

EL NOSTRE POBLE .- EL MEU BARRI

El nostre poble .- El meu barri.



ESTACIÓ DE TRENS
estació de trens



ESTACIÓ D'AUTOBUSOS
estació d'autobusos

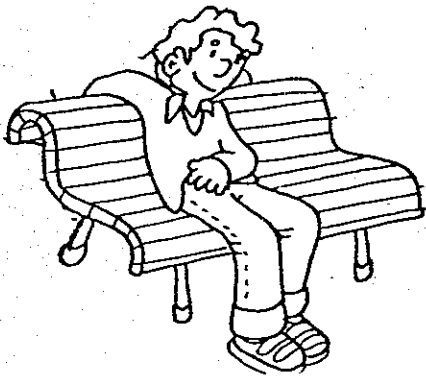

BANC
banc



REVISTA
revista

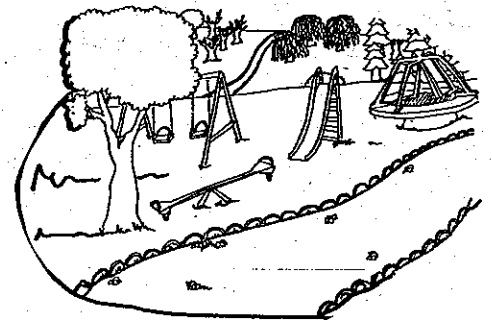

PLAÇA
plaza



JARDÍ
jardí

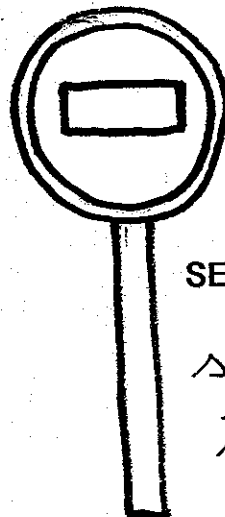

SENYAL DE TRÀNSIT
senyal de trànsit

BLOC Nº 2

EL NOSTRE POBLE .- EL MEU BARRI

VOCABULARI



FOTOGRAFIAR



SALUDAR

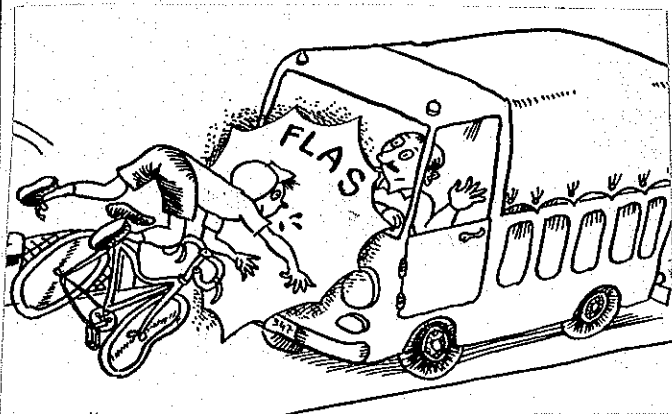

XOCAR



MIRAR

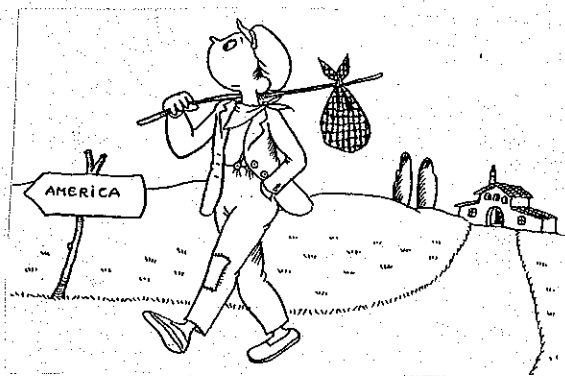

CAMINAR

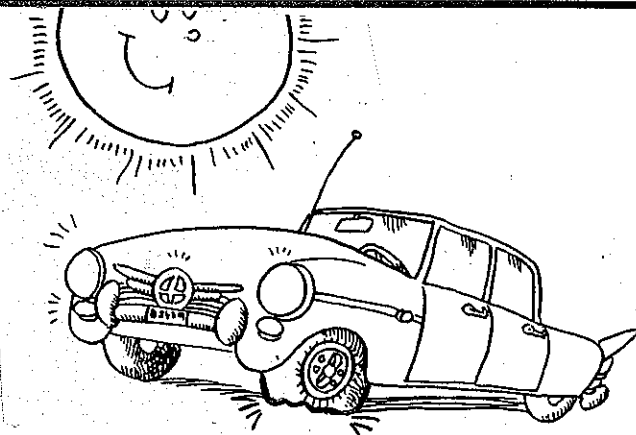

PUNXAR-SE UNA RODA

BLOC Nº 2

EL NOSTRE POBLE .- EL MEU BARRI

VOCABULARI



APAGAR

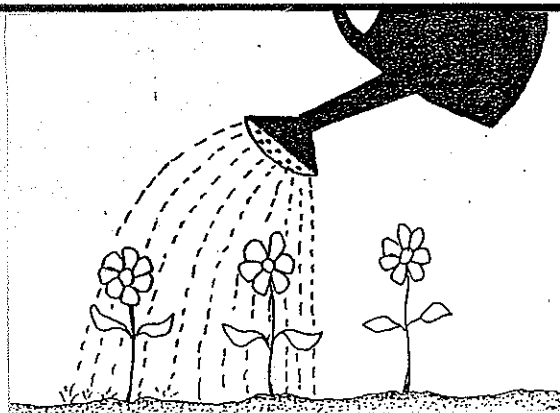

REGAR



PODAR

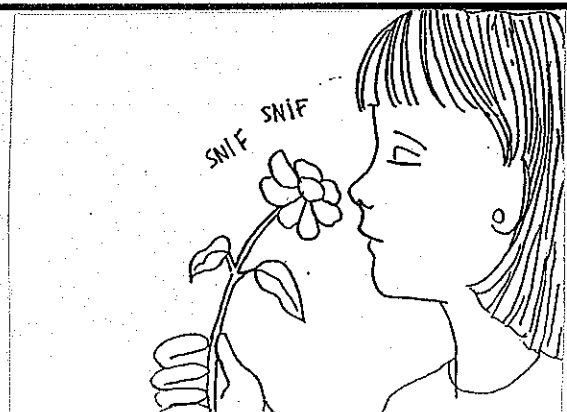

OLORAR

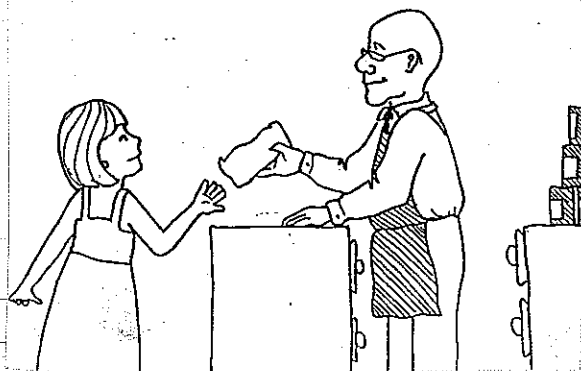

COMPRAR / VENDRE



ESCOMBRAR

BLOC Nº 2

EL NOSTRE POBLE .- EL MEU BARRI

VOCABULARI

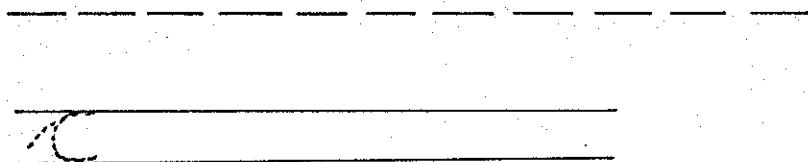
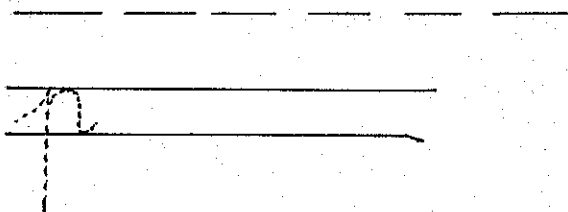
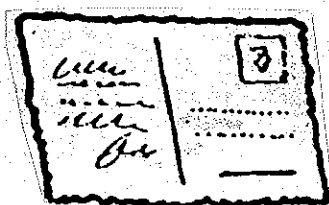
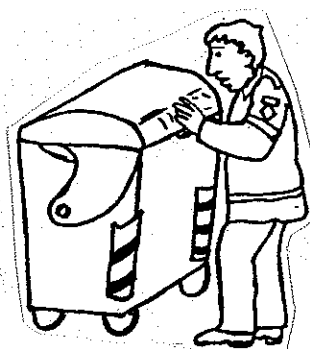
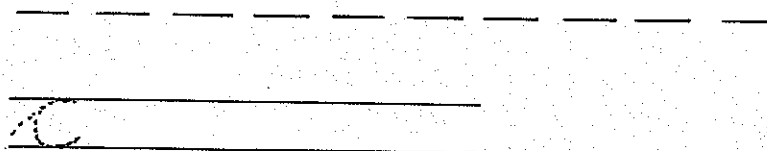
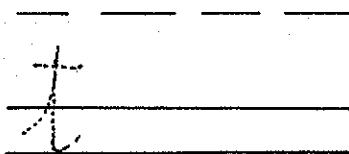
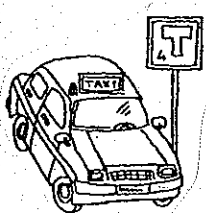

BLOC Nº 2

EL NOSTRE POBLE .- EL MEU BARRI

VOCABULARI

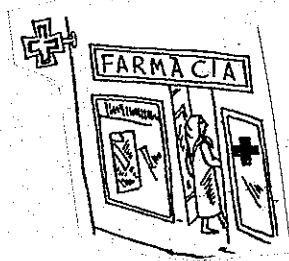



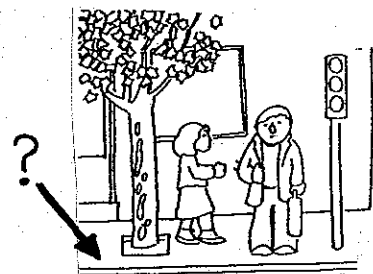

BLOC Nº 2

EL NOSTRE POBLE .- EL MEU BARRI

VOCABULARI

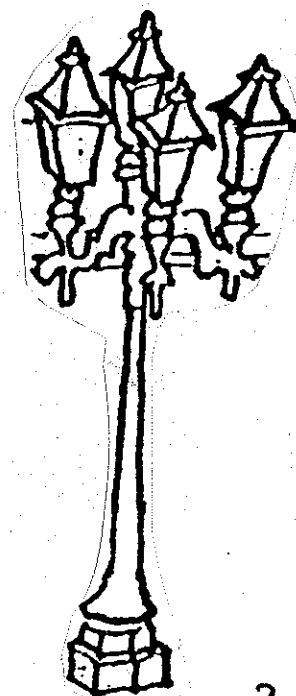
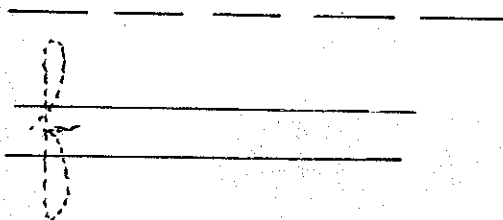
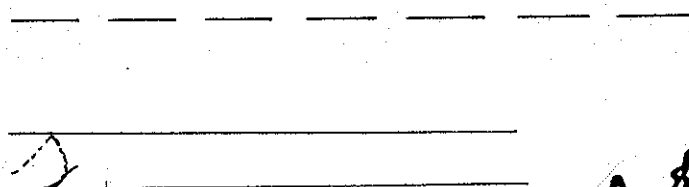
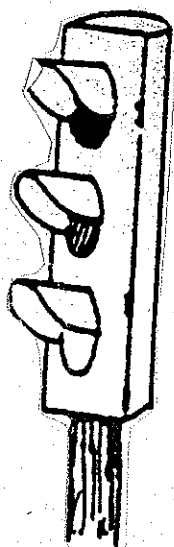
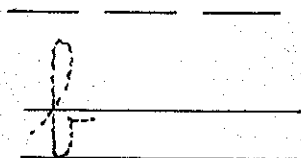
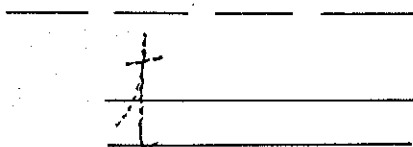
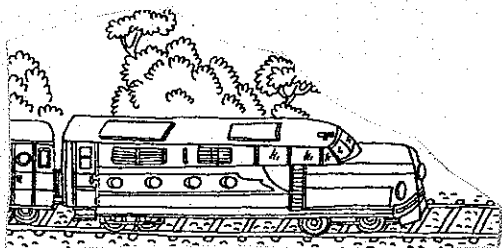

BLOC Nº 2

EL NOSTRE POBLE .- EL MEU BARRI

VOCABULARI



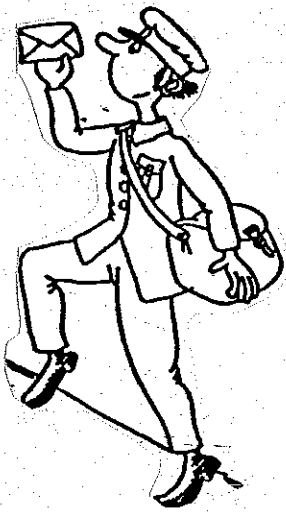
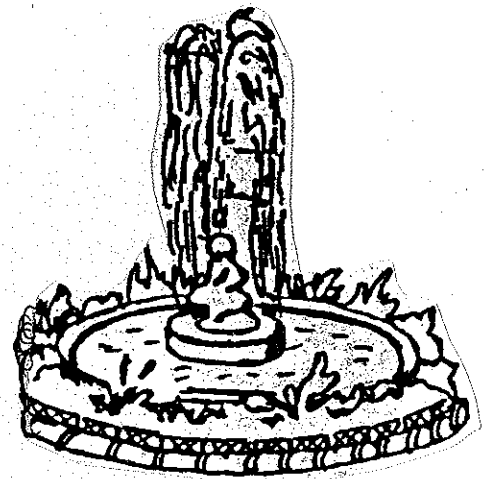



BLOC Nº 2

EL NOSTRE POBLE .- EL MEU BARRI

VOCABULARI

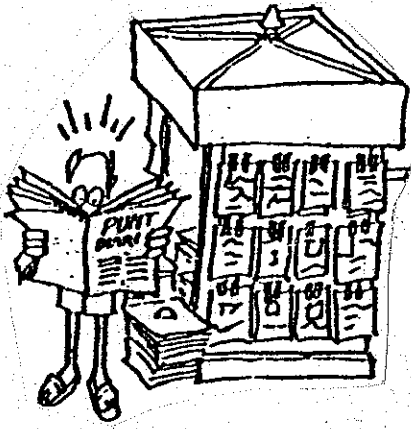



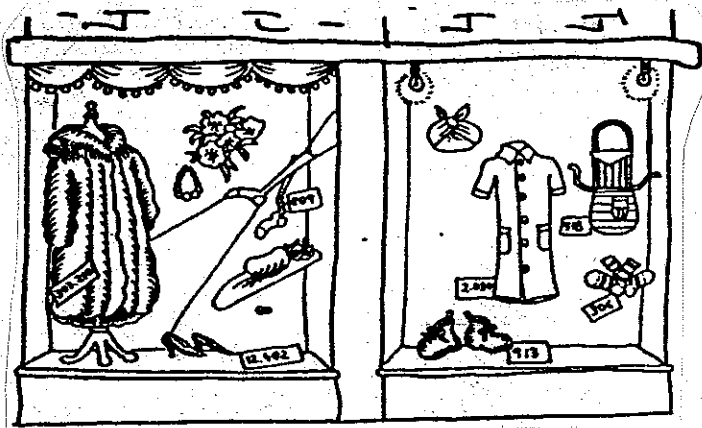

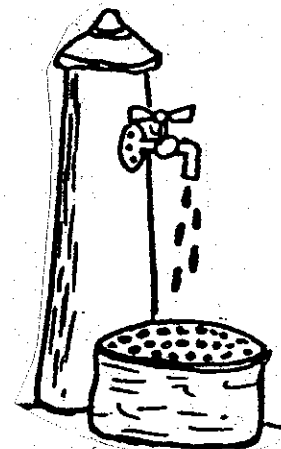

BLOC Nº 2

EL NOSTRE POBLE .- EL MEU BARRI

VOCABULARI

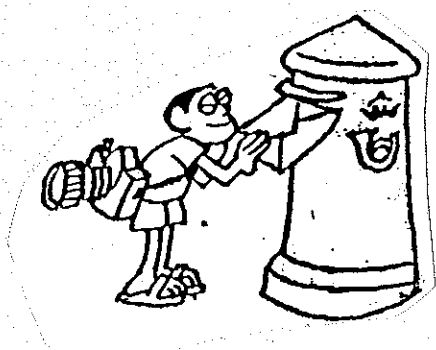

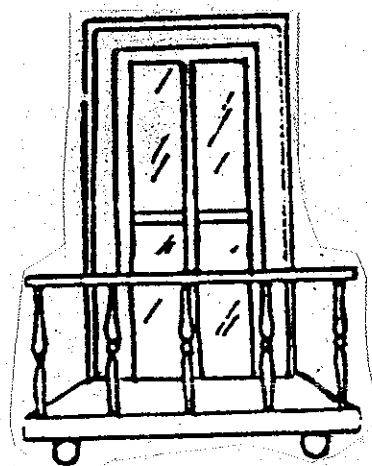

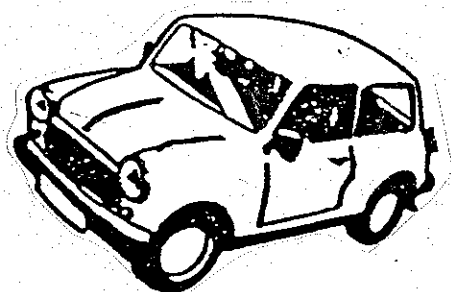

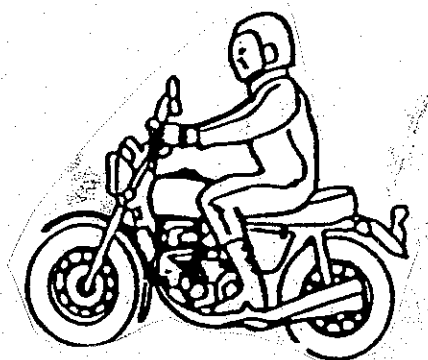

BLOC Nº 2

EL NOSTRE POBLE .- EL MEU BARRI

ENCREUATS DE PARAULES

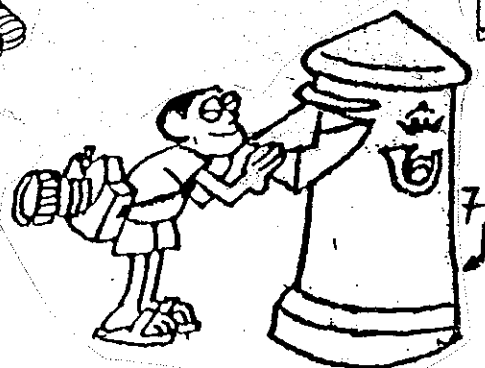
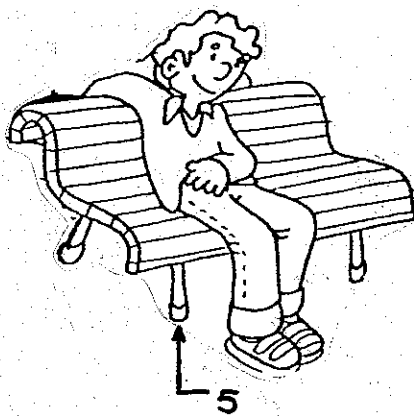
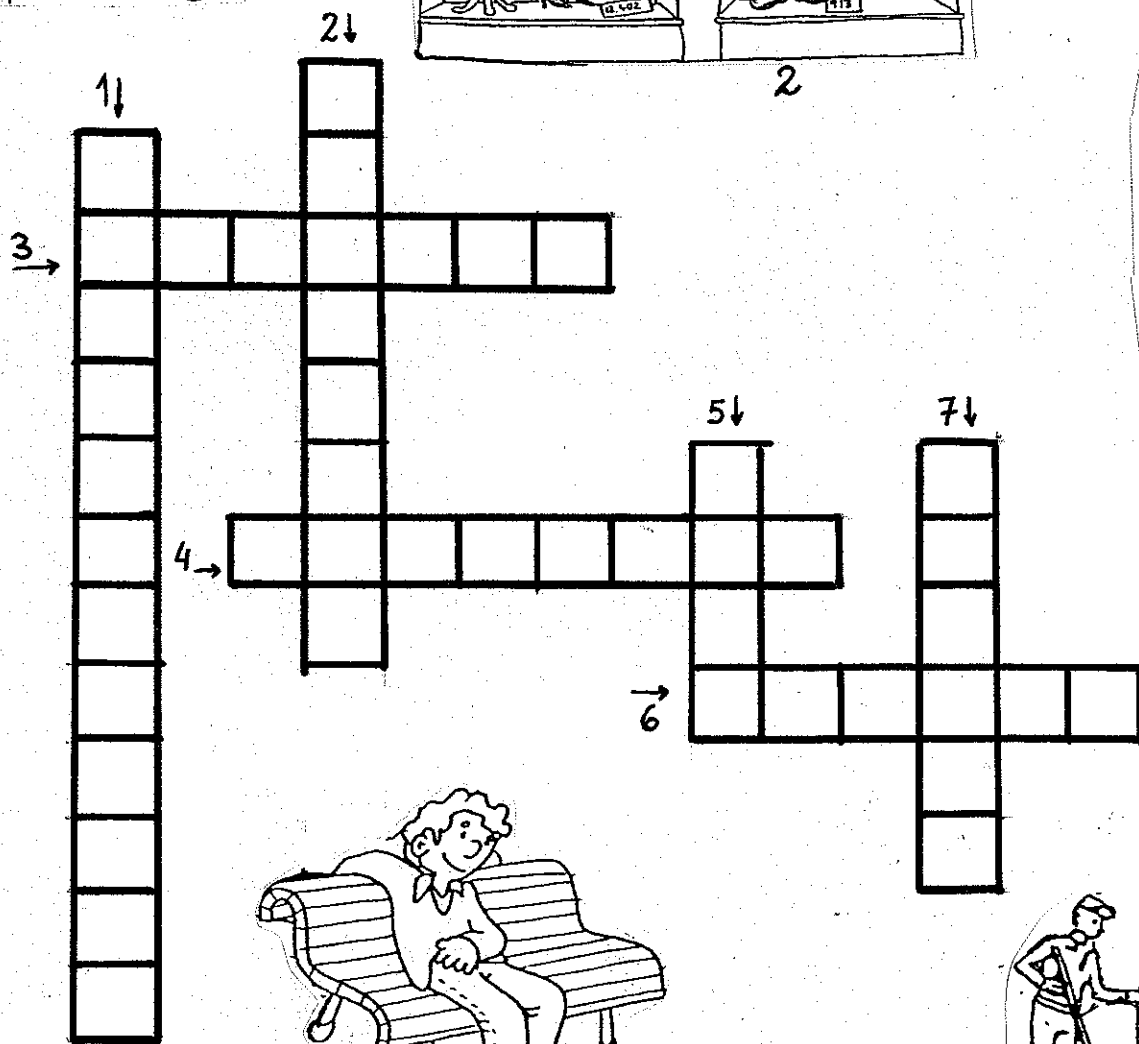
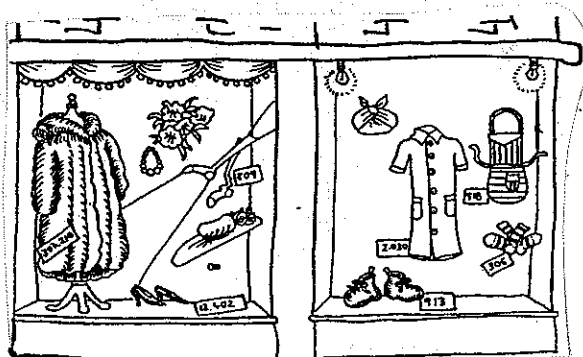
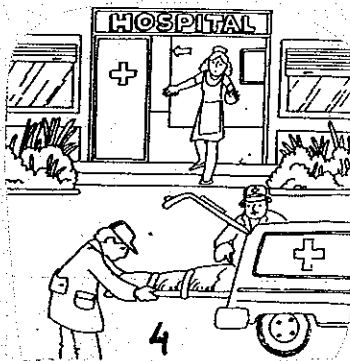

BLOC Nº 2

EL NOSTRE POBLE .- EL MEU BARRI

ENCREUATS DE PARAULES

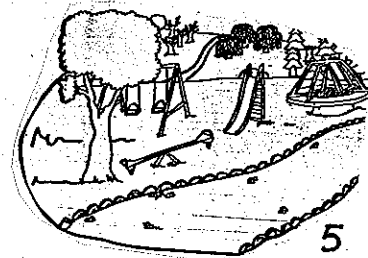
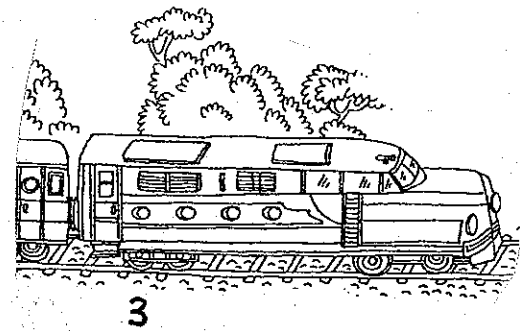
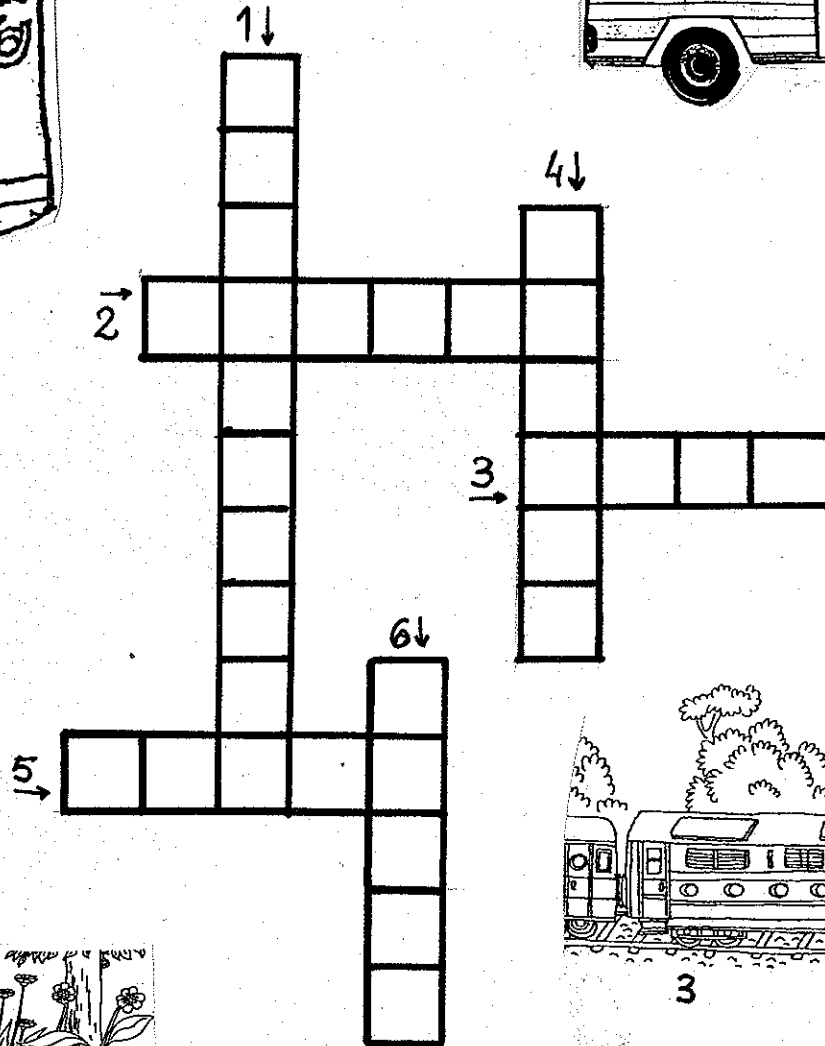
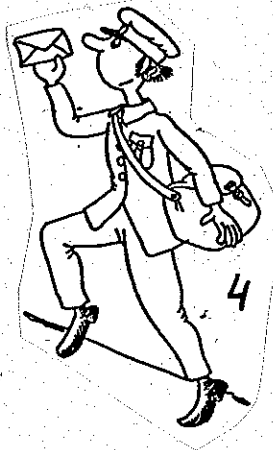
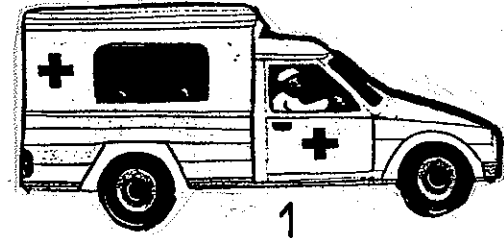

BLOC Nº 2

EL NOSTRE POBLE .- EL MEU BARRI

ENCREUATS DE PARAULES

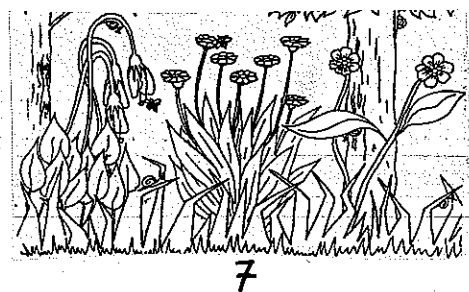
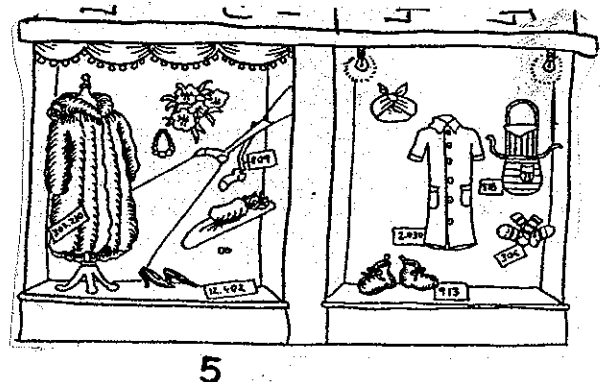
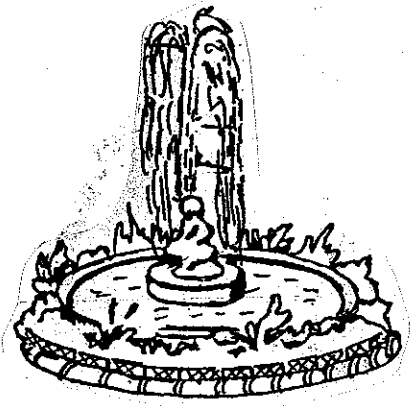
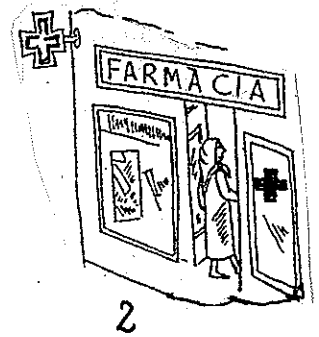
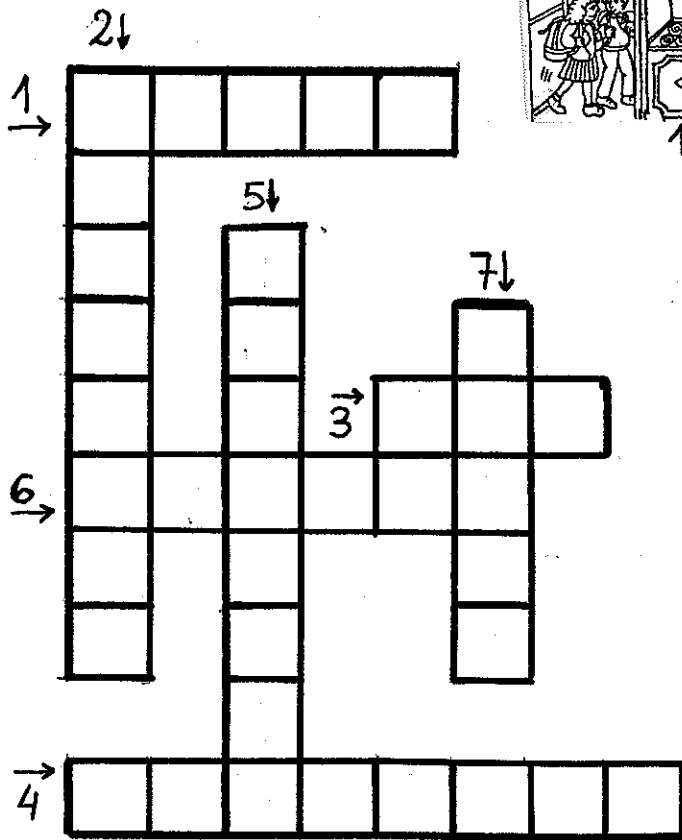

BLOC Nº 2

EL NOSTRE POBLE .- EL MEU BARRI

ENCREUATS DE PARAULES

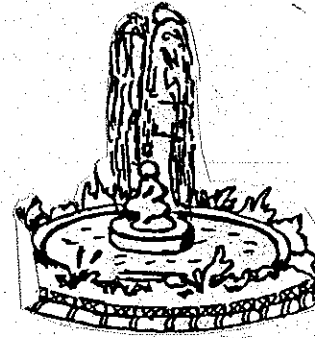
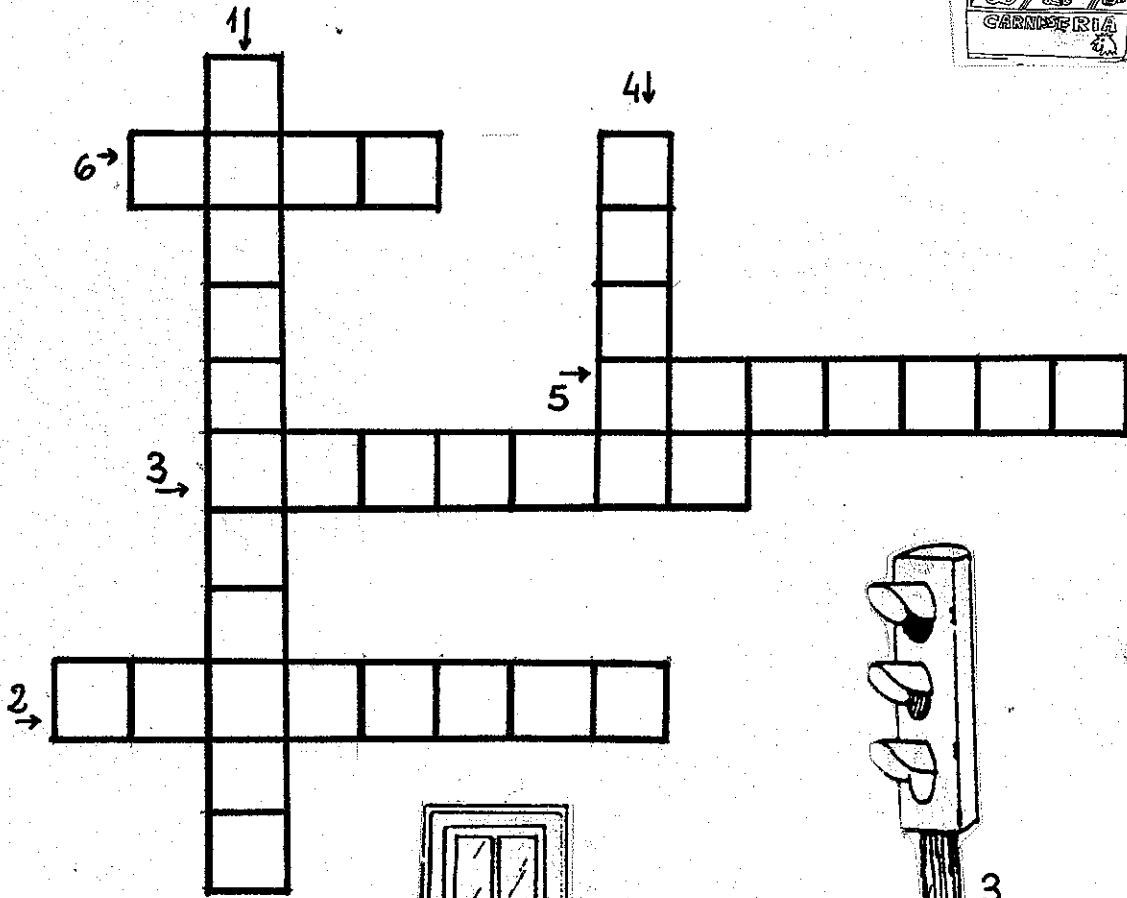

2



3

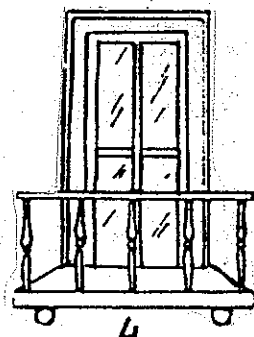

4

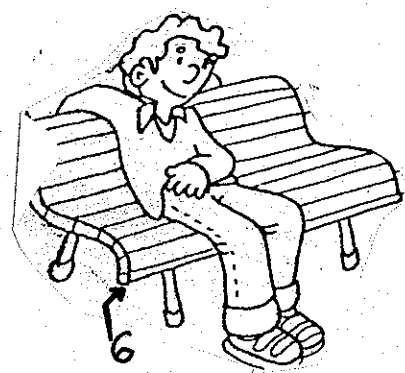

6



5

4..

BLOC Nº 2

EL NOSTRE POBLE .- EL MEU BARRI

EMBOLICS DE LLETRES

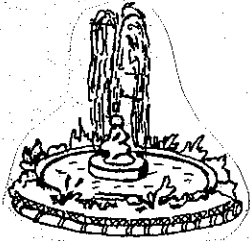

A	Z	X	U	V	T	S	R	A	W	Z
B	M	A	S	E	M	A	F	O	R	X
C	B	C	U	D	E	Q	A	B	C	V
D	O	P	R	H	I	P	R	D	E	U
E	Q	R	T	J	K	O	M	F	F	T
F	S	T	I	L	M	N	A	G	A	S
G	A	B	D	N	O	M	C	H	N	R
H	C	D	O	P	Q	L	I	I	A	Q
I	E	F	R	R	T	K	A	J	L	P
J	K	L	M	B	U	S	T	I	A	O

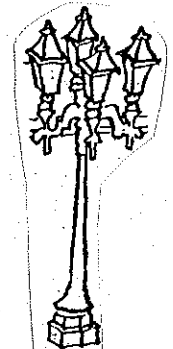
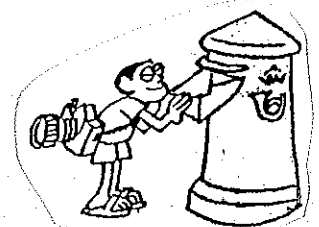
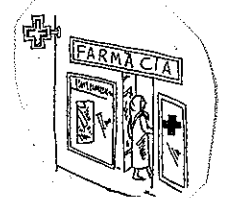

BLOC Nº 2

EL NOSTRE POBLE .- EL MEU BARRI

EMBOLICS DE LLETRES

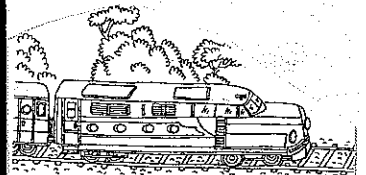
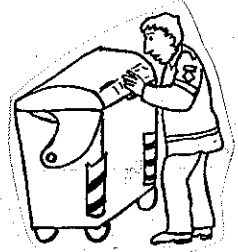
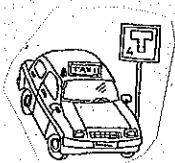
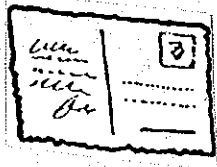

A	Q	R	B	A	C	D	E	F	H	G
B	P	S	T	V	M	L	K	J	O	H
C	O	T	P	O	S	T	A	L	S	I
D	N	U	O	T	O	A	P	Q	P	R
E	M	V	P	R	C	X	B	A	I	S
F	L	X	X	E	D	I	E	F	G	H
G	K	Y	W	N	O	N	M	L	K	I
C	O	N	T	E	N	I	D	O	R	Z
H	J	Z	M	O	P	Q	R	S	T	X
I	H	O	S	P	I	T	A	L	U	V



BLOC Nº 2

EL NOSTRE POBLE .- EL MEU BARRI

EMBOLICS DE LLETRES

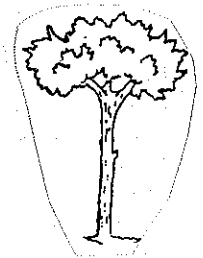
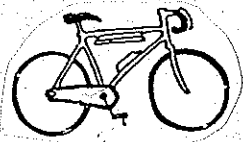
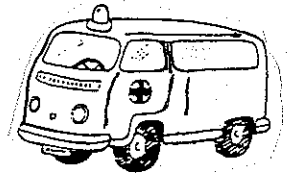
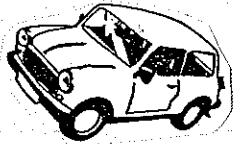

A	B	C	D	C	E	F	G	H	I	A
J	K	L	M	O	N	O	A	P	Q	M
A	Z	X	V	T	U	T	R	S	R	B
B	C	V	V	X	F	G	B	R	S	U
D	T	X	Z	E	E	H	R	Q	P	L
M	N	M	N	C	D	I	E	N	O	A
P	O	C	A	M	I	O	M	K	I	N
Q	R	P	Q	A	K	J	F	G	H	C
S	T	R	S	B	A	B	C	D	E	I
B	i	C	i	C	L	E	T	A	B	A



BLOC Nº 2

EL NOSTRE POBLE .- EL MEU BARRI

EMBOLICS DE LLETRES

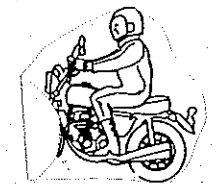
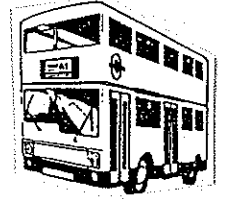
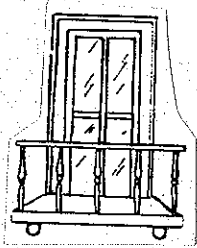

A	U	T	S	R	Q	P	O	N	M	V
B	A	D	E	H	I	K	N	O	A	U
C	B	C	F	G	J	L	M	P	U	T
D	F	L	O	R	T	S	R	Q	T	S
E	A	B	C	D	E	F	G	H	O	R
F	A	T	M	B	A	L	C	O	B	Q
G	N	P	M	T	Z	X	W	G	U	P
H	R	Q	A	B	C	D	E	F	S	O
E	S	C	O	M	B	R	I	A	I	R
I	M	O	T	O	J	K	L	M	N	E



BLOC Nº 2

EL NOSTRE POBLE .- EL MEU BARRI

EMBOLICS DE LLETRES

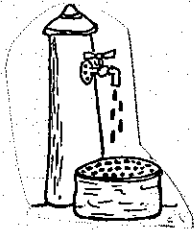

A	Q	R	S	T	M	A	T	S	W	A
B	P	O	N	C	B	P	A	M	X	M
C	X	Z	M	D	E	A	H	B	G	B
D	U	V	H	G	F	R	I	U	F	U
E	S	T	I	J	K	A	D	S	E	L
F	R	Q	F	L	M	D	C	T	B	A
G	O	P	O	N	P	O	M	I	N	N
H	N	M	N	K	A	R	L	A	K	C
I	K	L	T	C	B	D	E	J	I	I
J	S	E	G	E	L	L	F	G	H	A

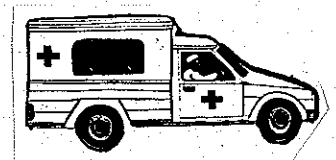
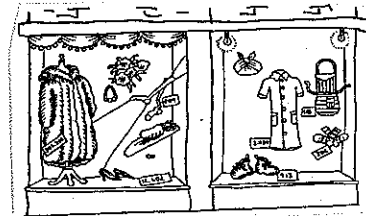

BLOC Nº 2

EL NOSTRE POBLE .- EL MEU BARRI

EMBOLICS DE LLETRES

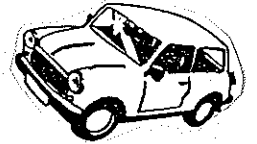

A	B	i	H	G	H	i	L	M	R	S
J	C	D	E	F	G	J	C	N	Q	T
K	A	N	R	Q	F	K	O	O	P	V
L	M	O	P	S	E	M	T	Z	X	W
W	i	V	U	T	D	N	X	Q	S	V
X	O	Z	A	B	C	P	E	R	T	U
B	A	O	M	O	T	O	i	H	G	X
C	R	P	N	M	L	K	J	E	F	Z
D	E	Q	B	A	L	C	O	D	C	A
A	M	B	U	L	A	N	C	i	A	B

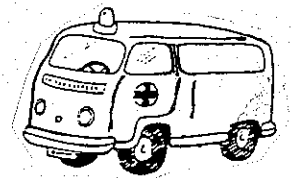
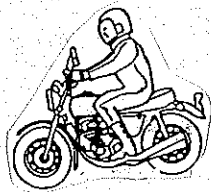
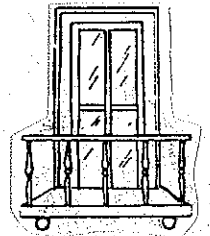

BLOC Nº 2

EL NOSTRE POBLE .- EL MEU BARRI

EMBOLICS DE LLETRES

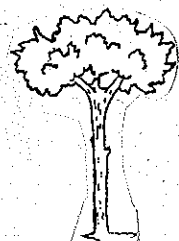

P	A	F	R	S	V	P	O	J	H	G
A	B	L	Q	T	T	Q	N	K	I	F
S	C	O	P	U	S	R	M	L	E	A
D	D	R	N	V	Q	A	B	C	D	U
E	E	L	M	W	P	T	W	Z	X	T
V	F	I	A	R	B	R	E	U	V	O
I	G	K	Z	X	P	Q	R	S	T	B
A	B	I	C	I	C	L	E	T	A	U
N	H	J	B	A	E	F	G	H	I	S
A	N	T	S	C	D	N	M	L	K	J

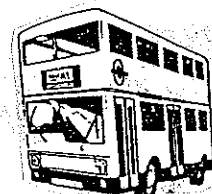
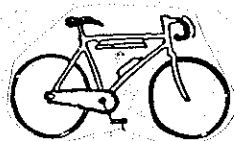
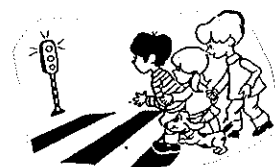

BLOC Nº 2

EL NOSTRE POBLE .- EL MEU BARRI

QUIN DIBUIX S'HI AMAGA ?

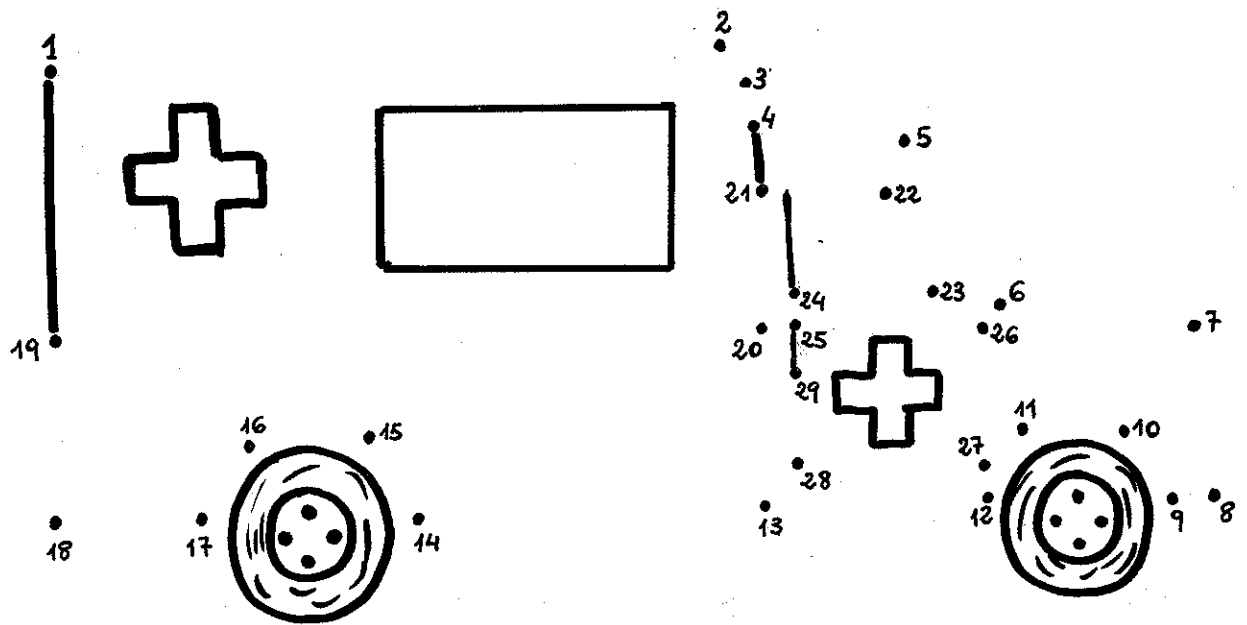

BLOC Nº 2

EL NOSTRE POBLE .- EL MEU BARRI

QUIN DIBUIX S'HI AMAGA ?.

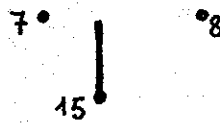
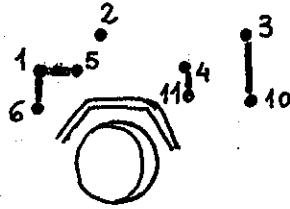

14 •

• 13

BLOC Nº 2

EL NOSTRE POBLE .- EL MEU BARRI

QUIN DIBUIX S'HI AMAGA ?.

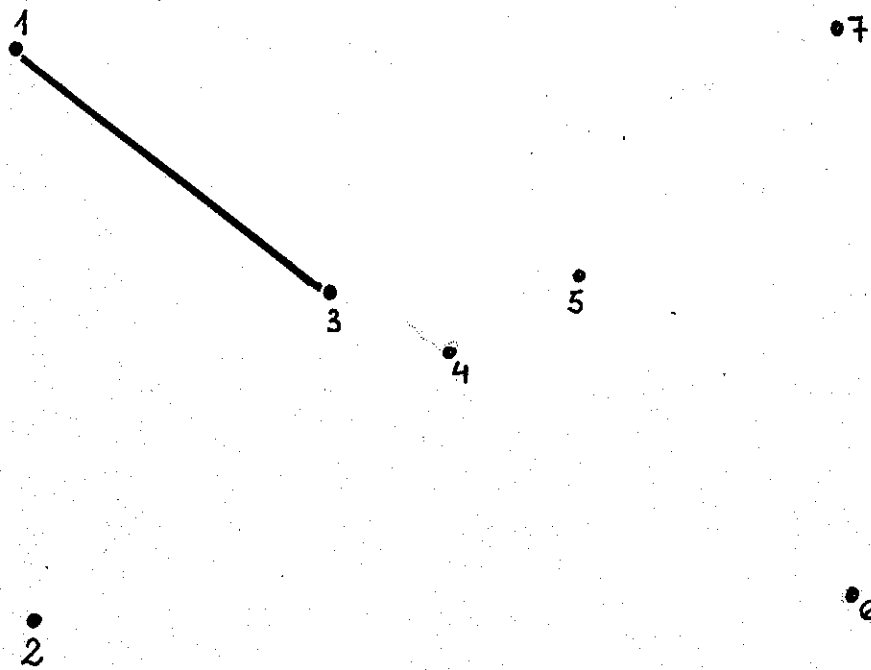

BLOC Nº 2

EL NOSTRE POBLE .- EL MEU BARRI

QUIN DIBUIX S'HI AMAGA ?.

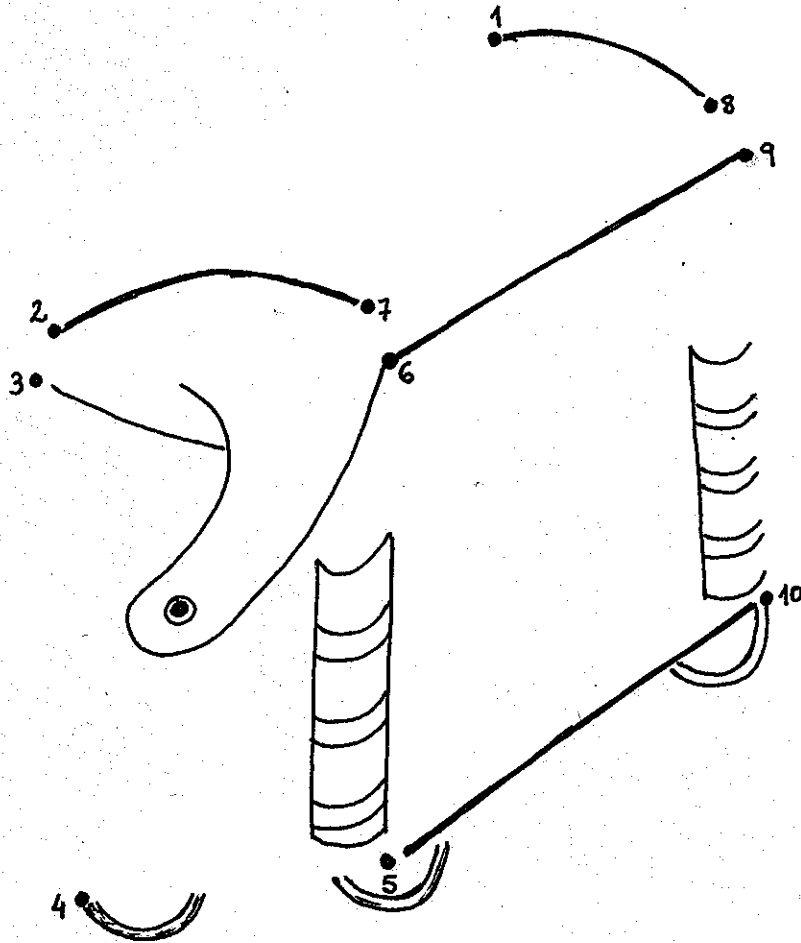

BLOC N° 2

EL NOSTRE POBLE .- EL MEU BARRI

QUIN DIBUIX S'HI AMAGA ?.

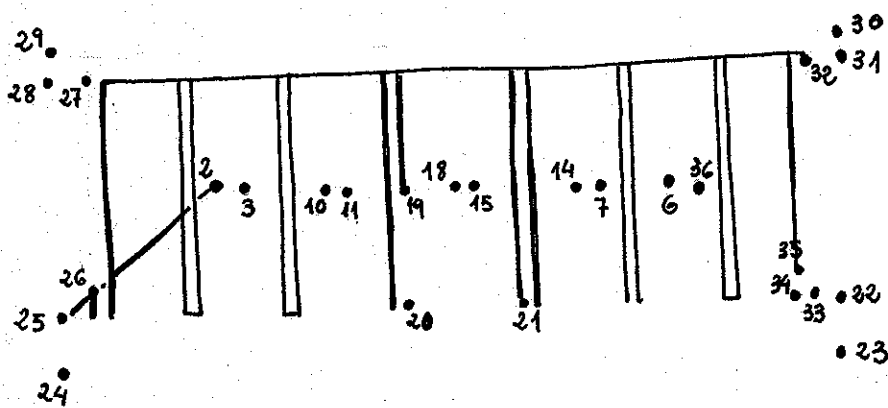
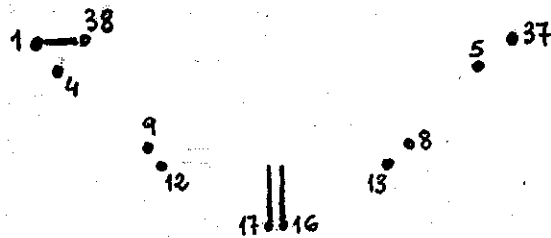

BLOC Nº 2

EL NOSTRE POBLE .- EL MEU BARRI

QUIN DIBUIX S'HI AMAGA ?

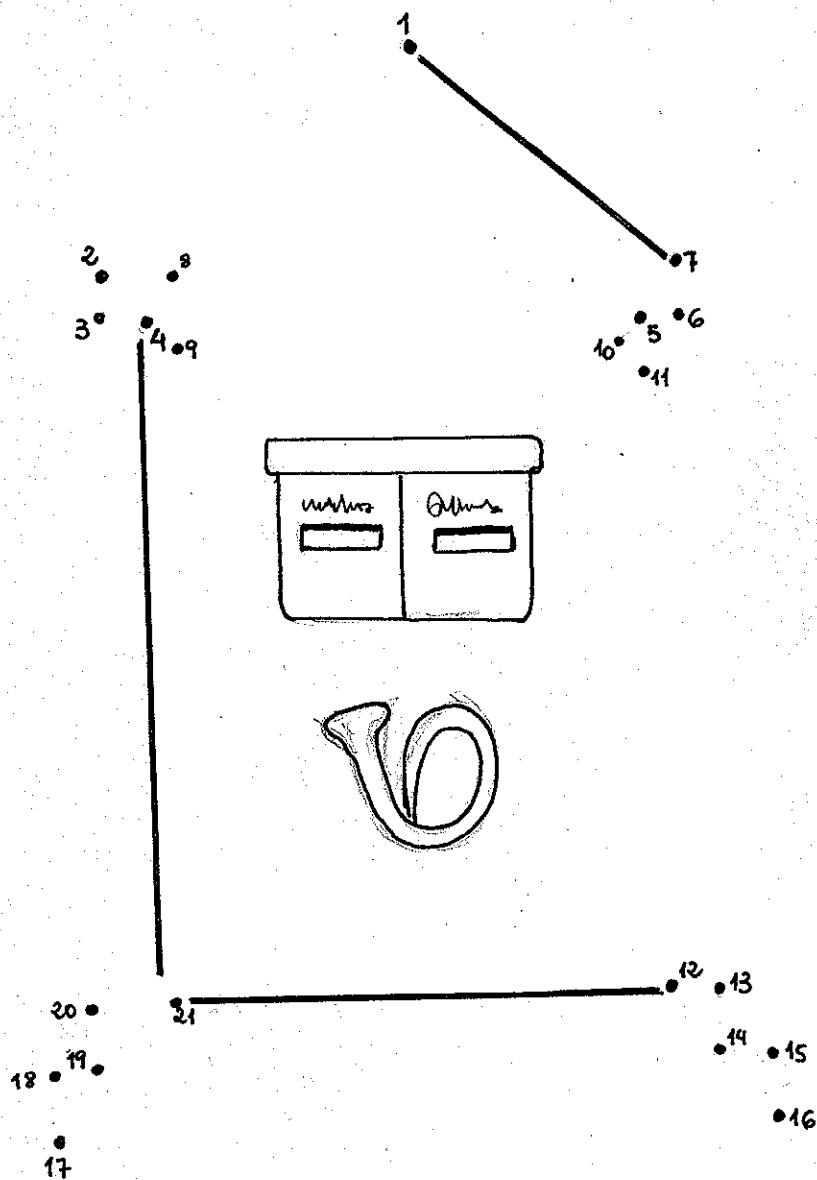

BLOC Nº 2

EL NOSTRE POBLE .- EL MEU BARRI

CADA LLETRA AL SEU LLOC

1	A
2	B
3	C
4	D
5	E
6	F
7	G
8	H
9	I
10	J
11	K
12	L
13	LL
14	M
15	N
16	O
17	P
18	Q
19	R
20	S
21	T
22	U
23	V
24	X
25	Y
26	Z



8 16 20 17 9 21 1 12

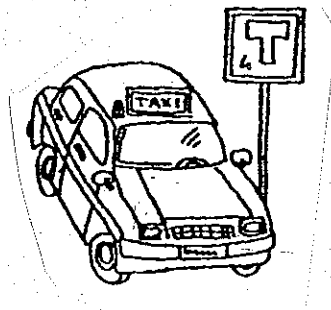

21 1 24 9

BLOC N° 2

EL NOSTRE POBLE .- EL MEU BARRI

CADA LLETRA AL SEU LLOC

1	A
2	B
3	C
4	D
5	E
6	F
7	G
8	H
9	I
10	J
11	K
12	L
13	LL
14	M
15	N
16	O
17	P
18	Q
19	R
20	S
21	T
22	U
23	V
24	X
25	Y
26	Z

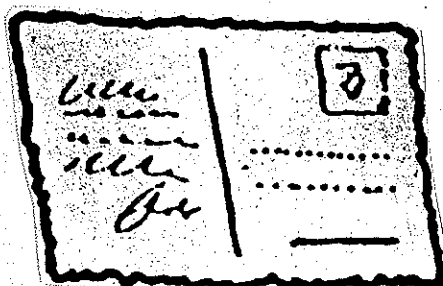

17 16 20 21 1 12



2 1 19

BLOC Nº 2

EL NOSTRE POBLE .- EL MEU BARRI

CADA LLETRA AL SEU LLOC

1	A
2	B
3	C
4	D
5	E
6	F
7	G
8	H
9	I
10	J
11	K
12	L
13	LL
14	M
15	N
16	O
17	P
18	Q
19	R
20	S
21	T
22	U
23	V
24	X
25	Y
26	Z



3 1 19 15 9 20 20 5 19 9 1



3 16 15 21 5 15 9 4 16 19

BLOC Nº 2

EL NOSTRE POBLE .- EL MEU BARRI

CADA LLETRA AL SEU LLOC

1	A
2	B
3	C
4	D
5	E
6	F
7	G
8	H
9	I
10	J
11	K
12	L
13	LL
14	M
15	N
16	O
17	P
18	Q
19	R
20	S
21	T
22	U
23	V
24	X
25	Y
26	Z

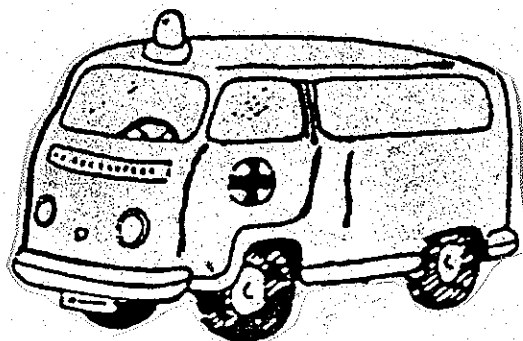

1 14 2 22 12 1 15 3 9 1

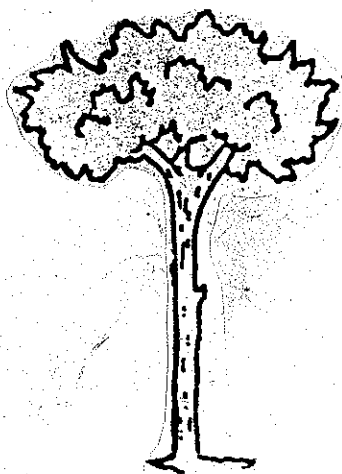

1 19 2 19 5

BLOC Nº 2

EL NOSTRE POBLE .- EL MEU BARRI

CADA LLETRA AL SEU LLOC

1	A
2	B
3	C
4	D
5	E
6	F
7	G
8	H
9	I
10	J
11	K
12	L
13	LL
14	M
15	N
16	O
17	P
18	Q
19	R
20	S
21	T
22	U
23	V
24	X
25	Y
26	Z

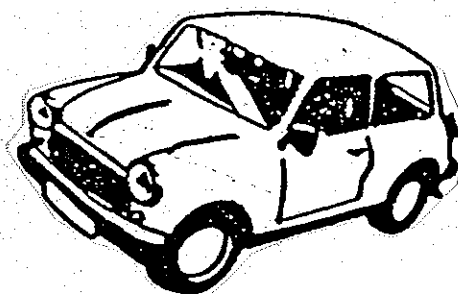

3 16 21 24 5

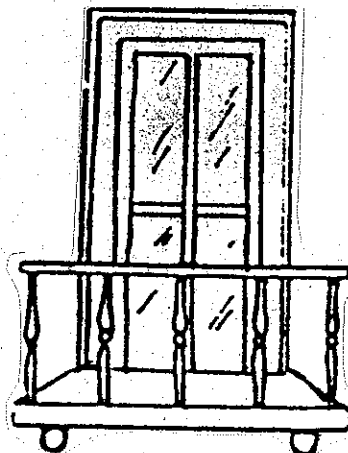

2 1 12 3 16

BLOC Nº 2

EL NOSTRE POBLE .- EL MEU BARRI

CADA LLETRA AL SEU LLOC

1	A
2	B
3	C
4	D
5	E
6	F
7	G
8	H
9	I
10	J
11	K
12	L
13	LL
14	M
15	N
16	O
17	P
18	Q
19	R
20	S
21	T
22	U
23	V
24	X
25	Y
26	Z

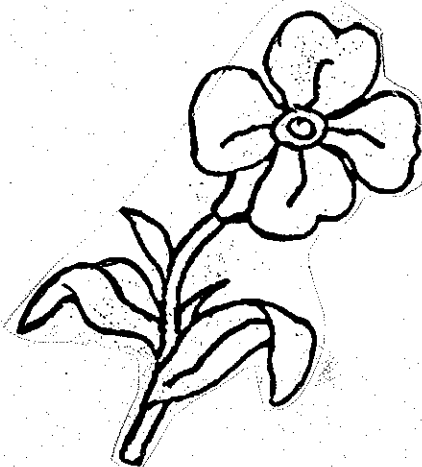

6 12 16 19

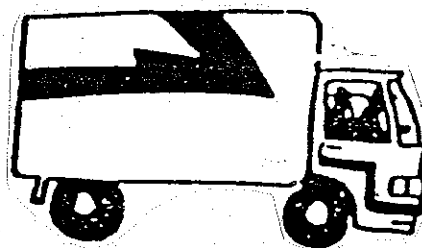

3 1 14 9 16

BLOC Nº 2

EL NOSTRE POBLE .- EL MEU BARRI

ESTRUCTURACIÓ DE FRASES .- LECTOESCRITURA



CARTER
carter

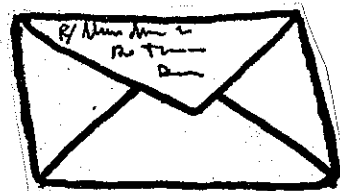

CARTA
carta

--	--

--	--	--	--	--	--

--	--	--	--	--

--	--	--

--	--	--	--	--

el carter porta una carta

BLOC Nº 2

EL NOSTRE POBLE .- EL MEU BARRI

ESTRUCTURACIÓ DE FRASES .- LECTOESCRITURA



GUÀRDIA MUNICIPAL

guàrdia municipal

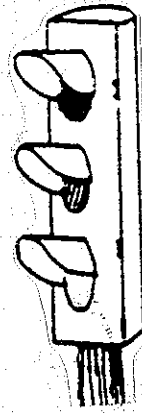

SEMÀFOR

semàfor

--	--

--	--	--	--	--	--	--	--

--	--	--	--

--	--

--	--	--	--	--	--	--	--

el guàrdia mira el semàfor

BLOC Nº 2

EL NOSTRE POBLE .- EL MEU BARRI

ESTRUCTURACIÓ DE FRASES .- LECTOESCRITURA

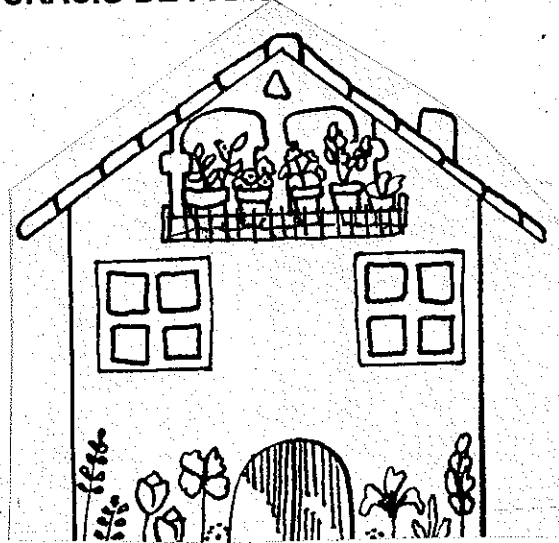

en el balcó hi ha moltes flors.
